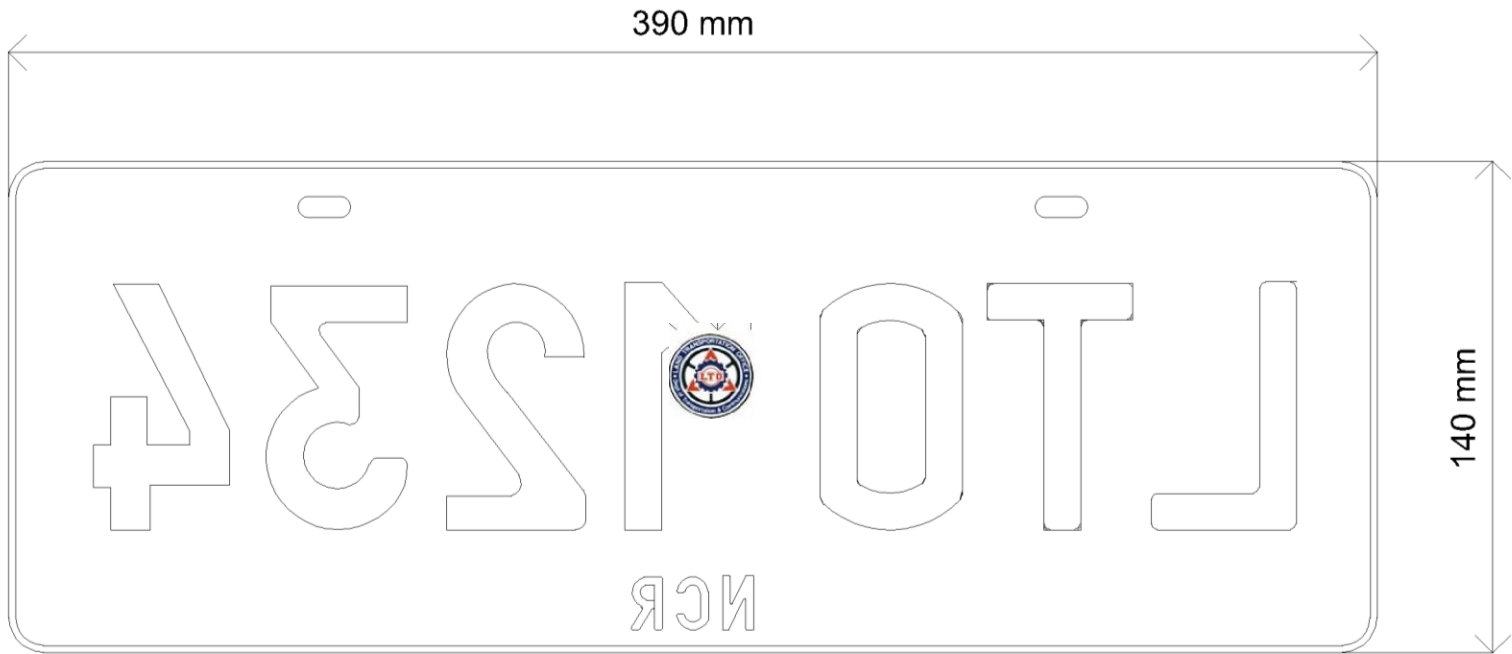

PLATE STANDARDIZATION

**PRIVATE MV
PLATE**



PLAN



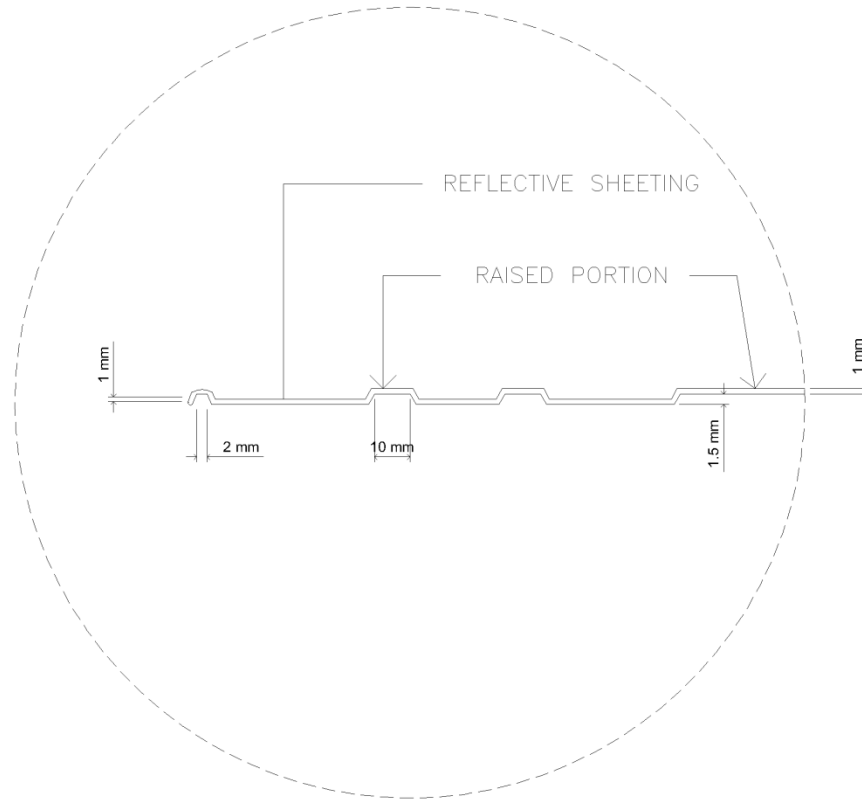

PLAN

**MC PRIVATE
PLATE**



PLAN



BACK VIEW

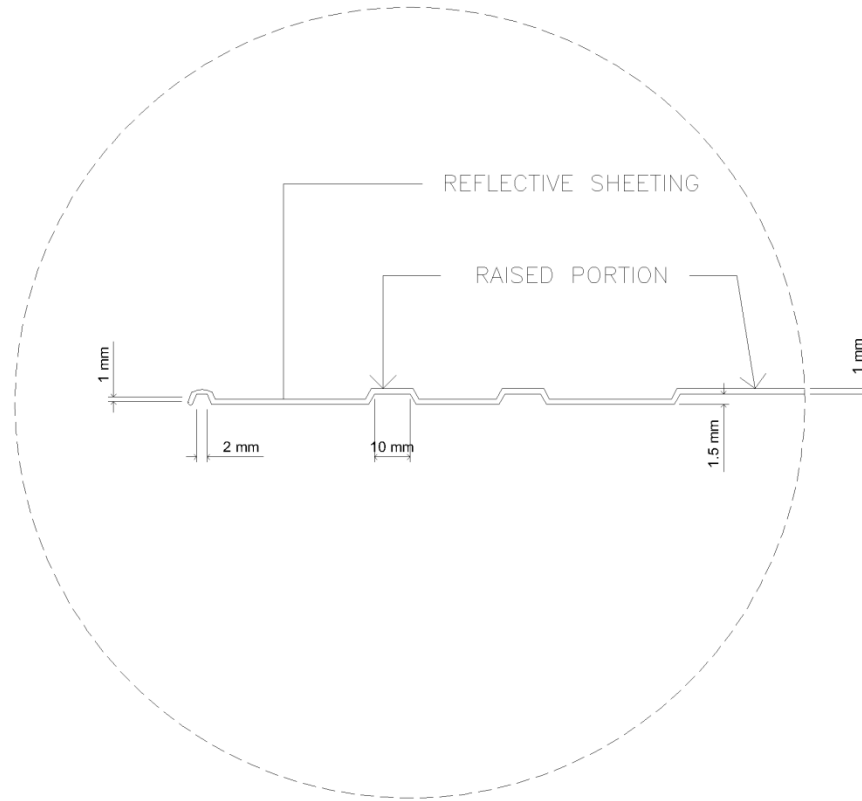

PLAN

GOVERNMENT PLATE

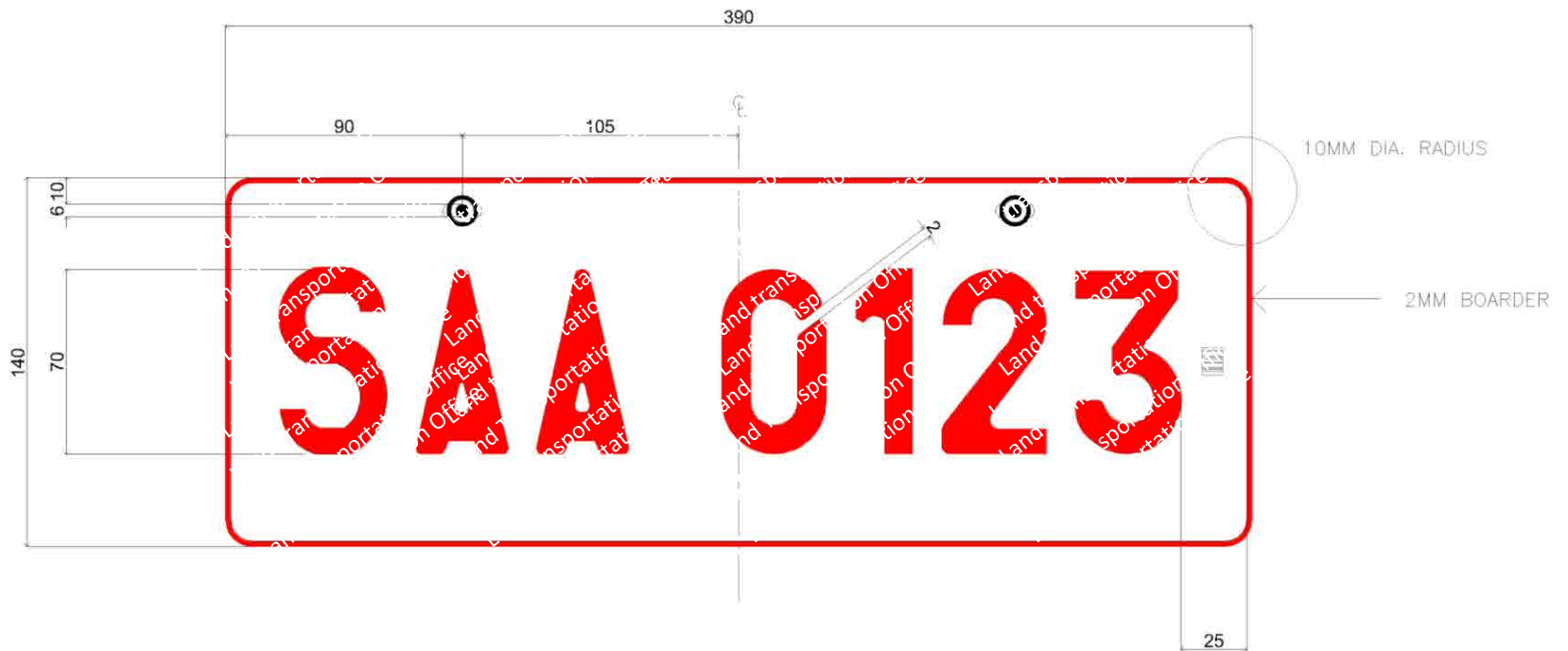

PLAN

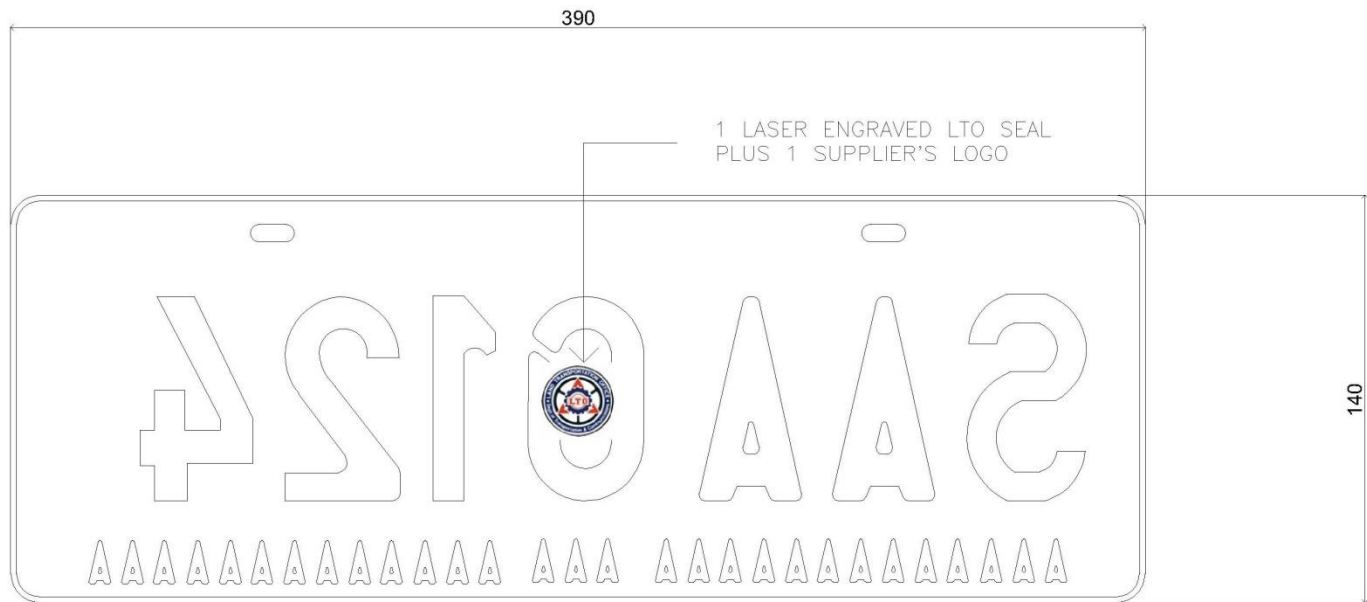

BACK VIEW

PROTOCOL PLATE

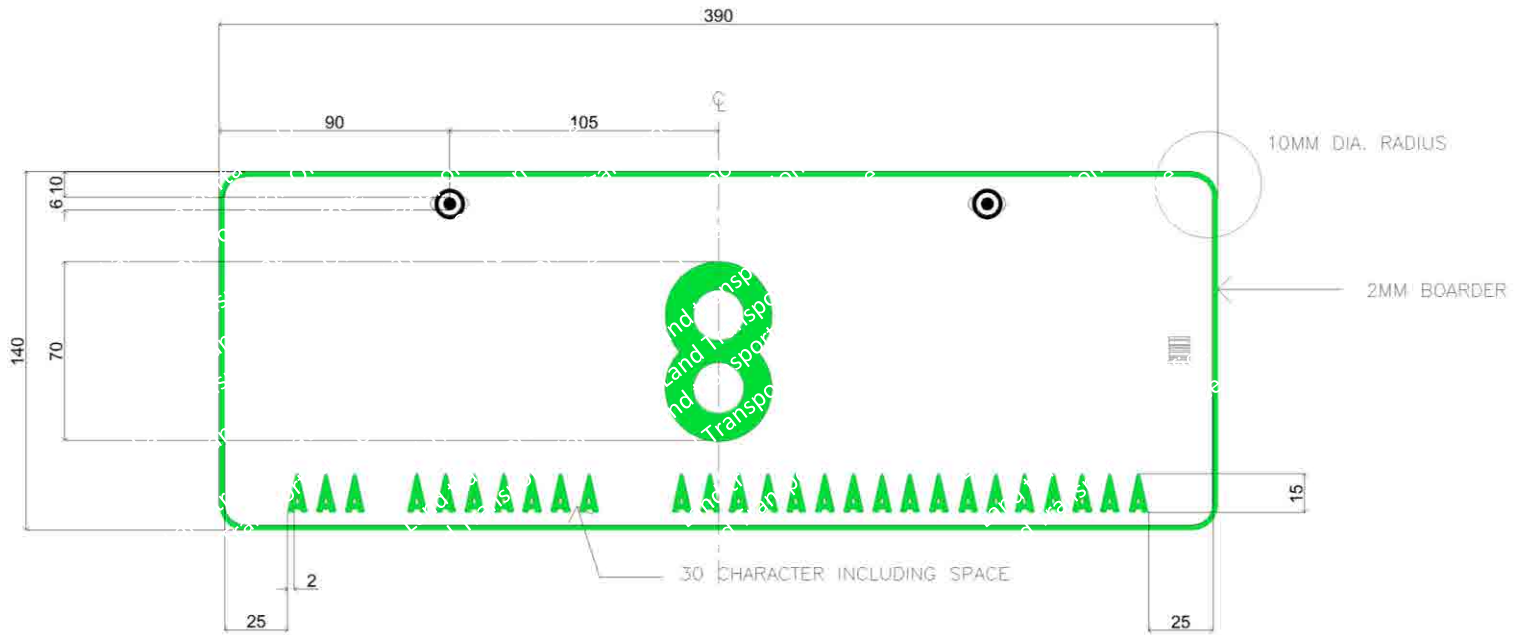

PLAN

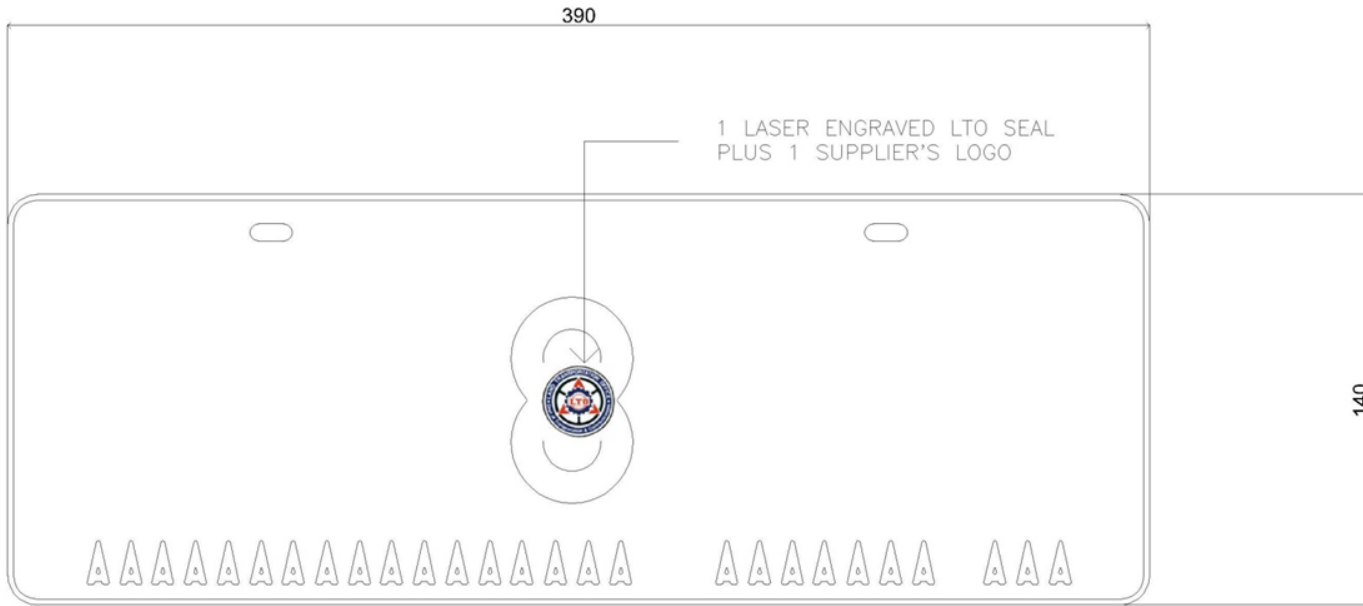

BACK VIEW

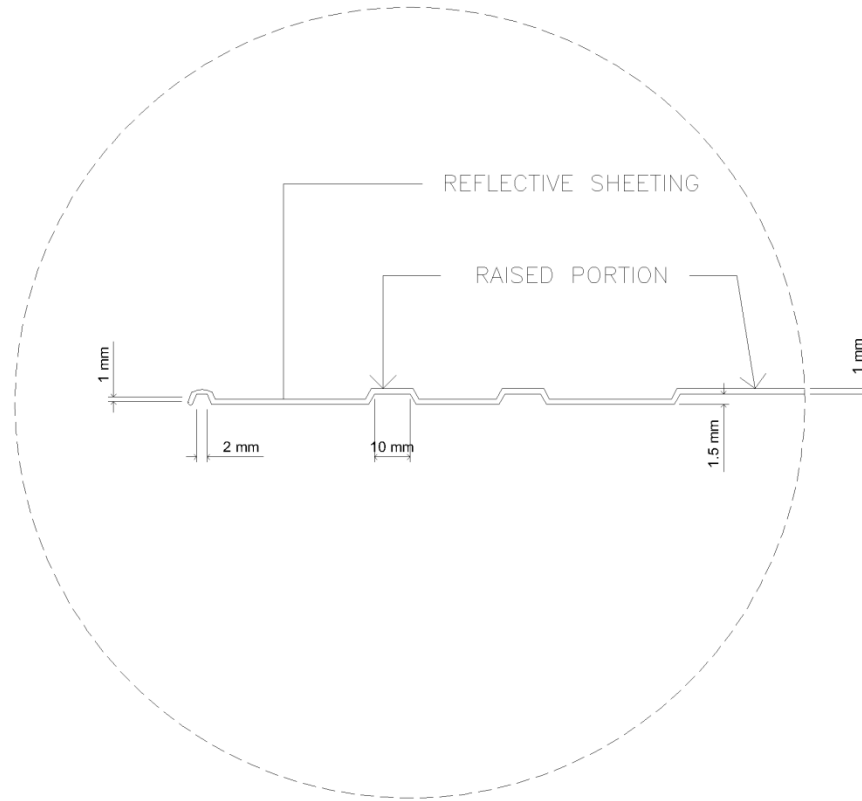

PLAN

**DIPLOMAT
PLATE**

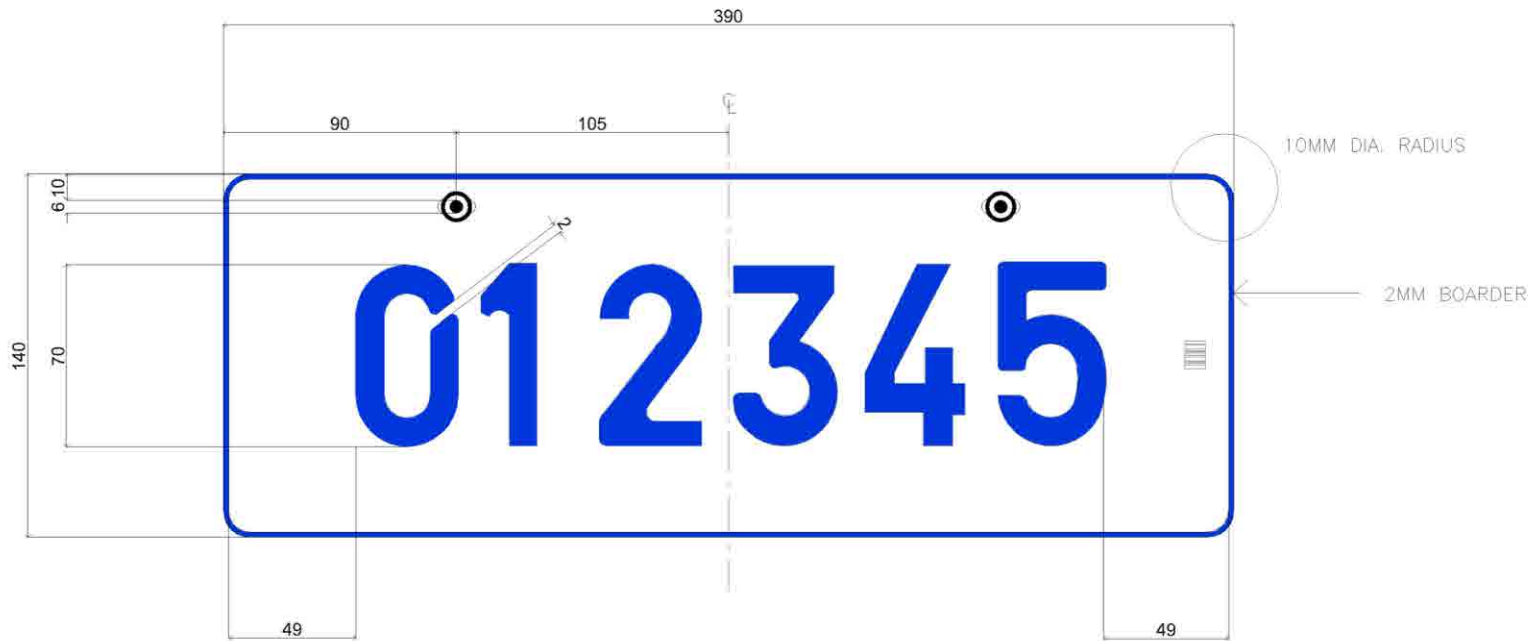

PLAN

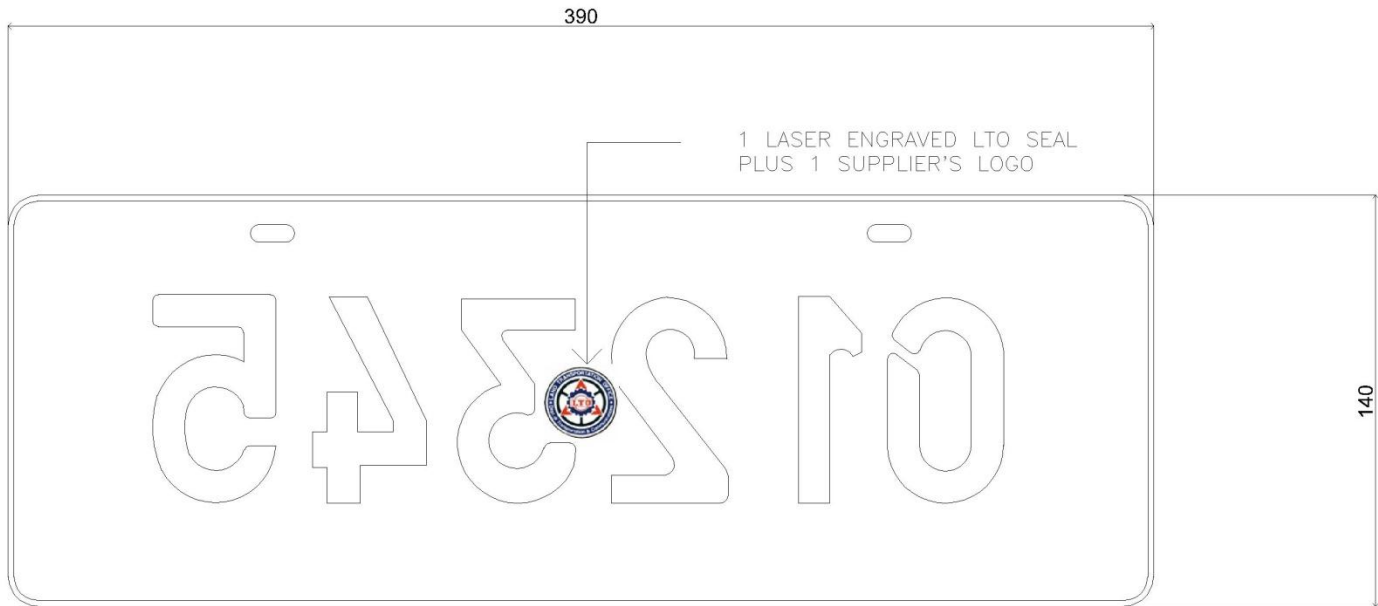

BACK VIEW

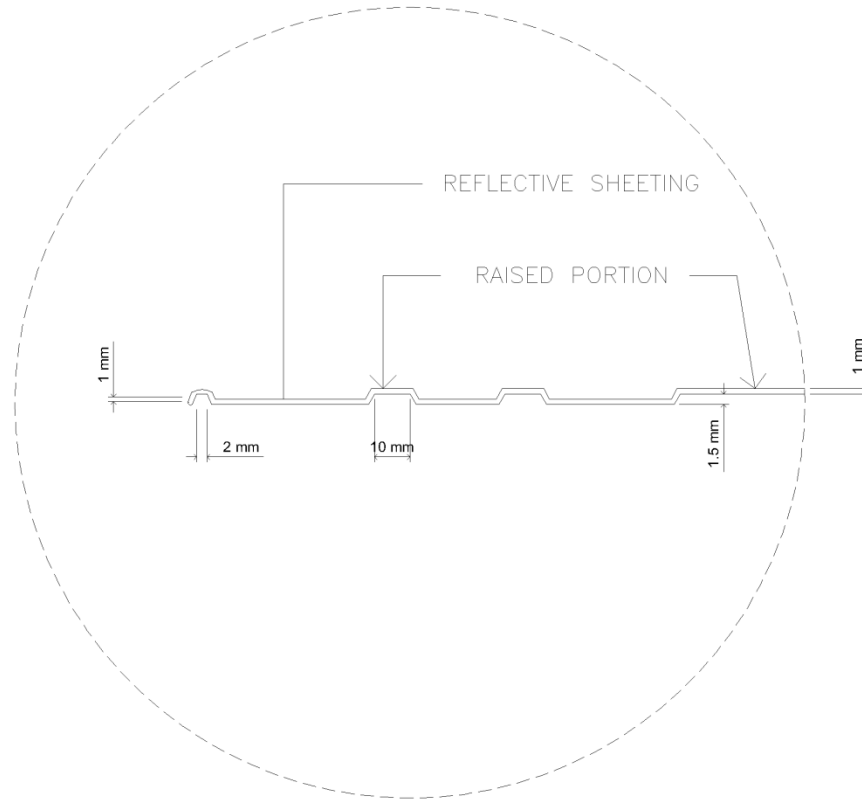

PLAN

PUB PLATE

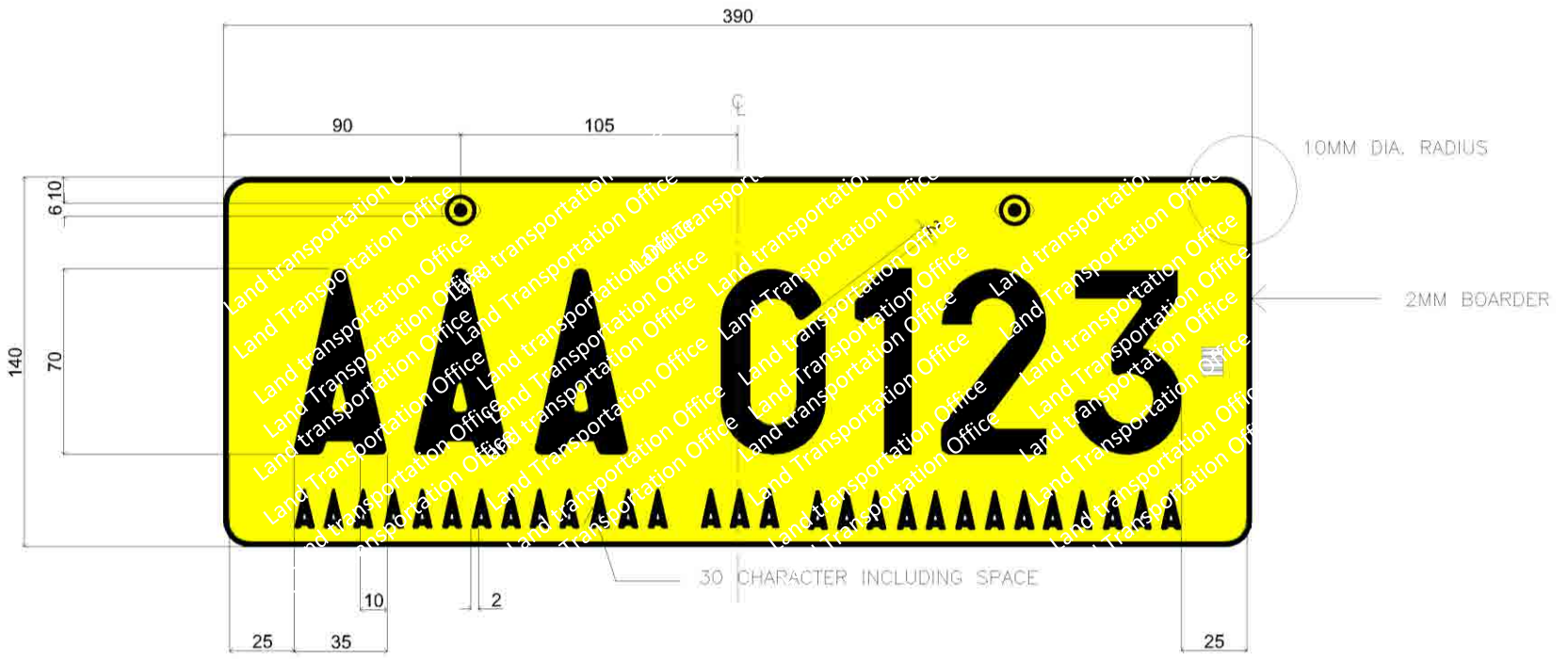

PLAN

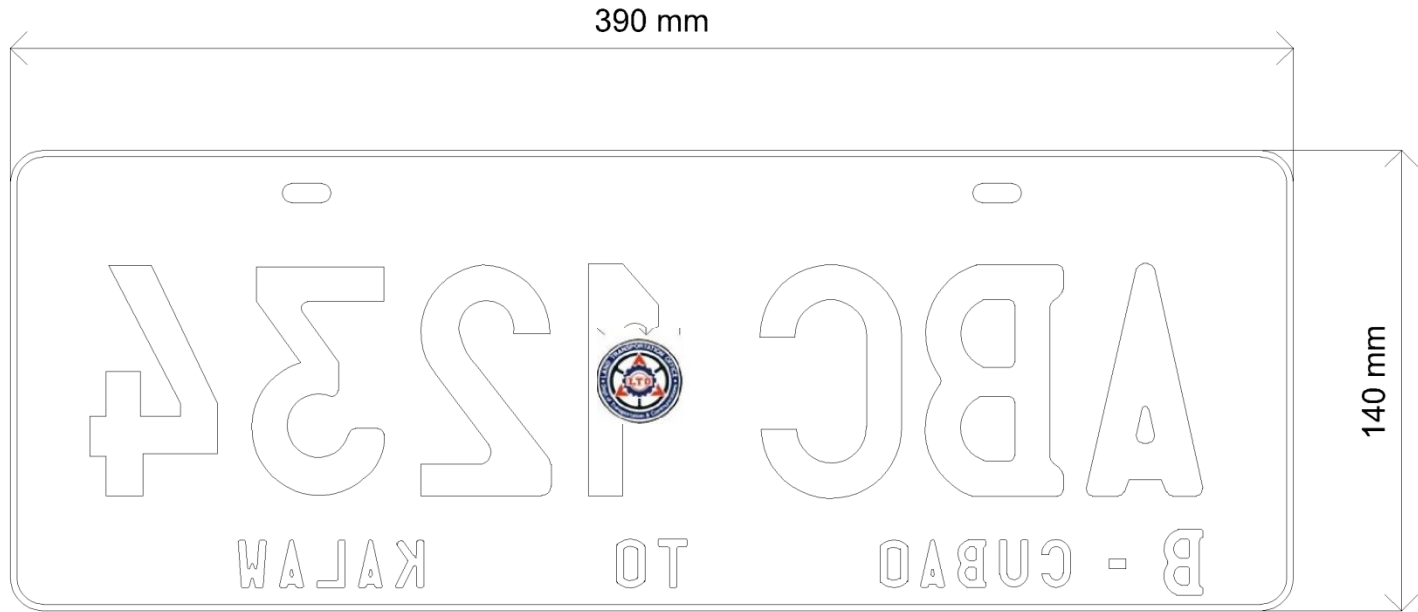

BACK VIEW

OEV PLATE



PLAN

390

1 LASER ENGRAVED LTO SEAL
PLUS 1 SUPPLIER'S LOGO

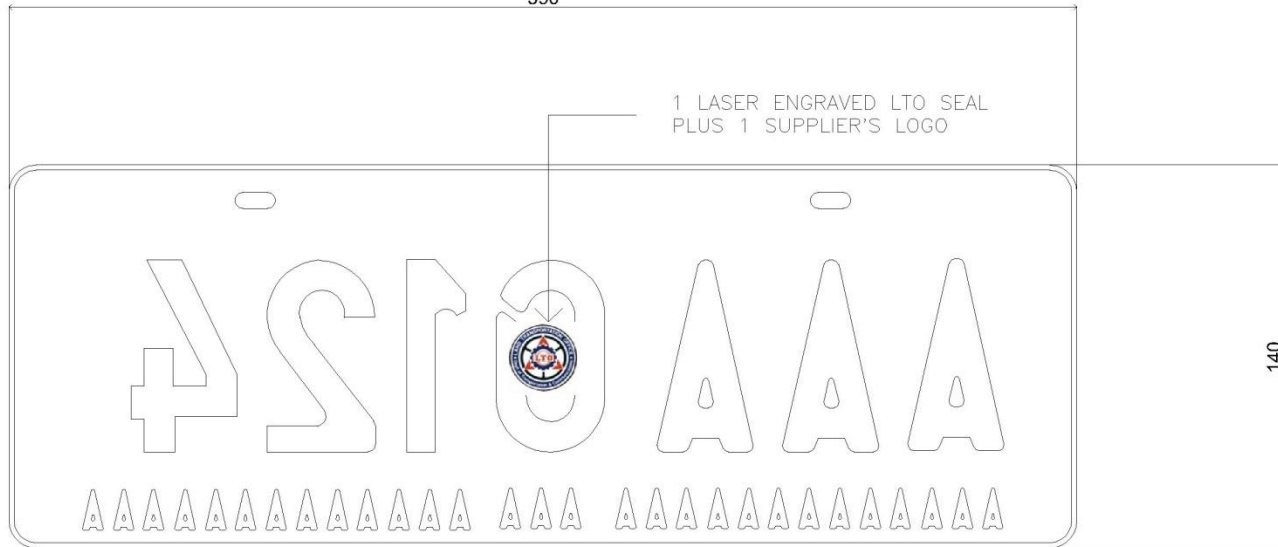

140

BACK VIEW

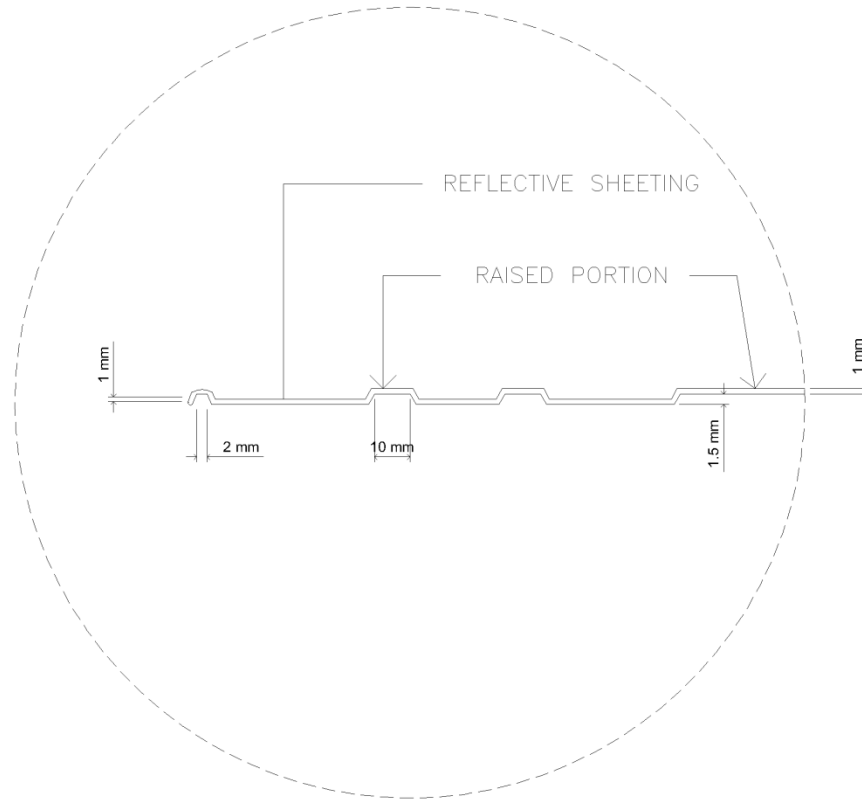

PLAN

**MC FOR HIRE
PLATE**



BACK VIEW

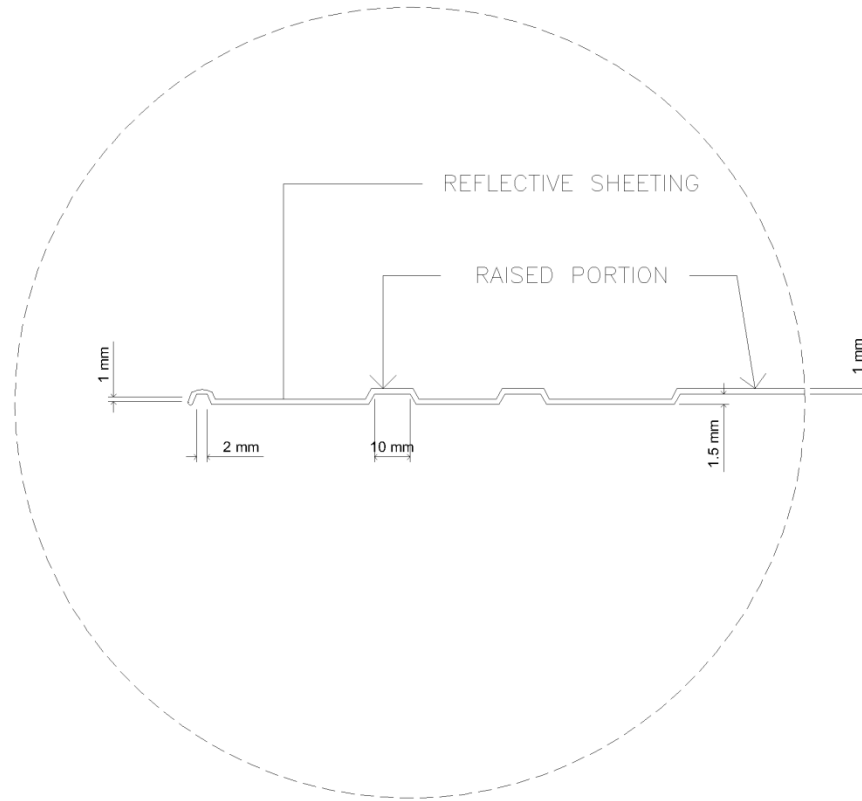

PLAN

**BOLT
ATTACHMENT
WITH
WASHER**

Bolt attachment

STANDARD BOLT 1

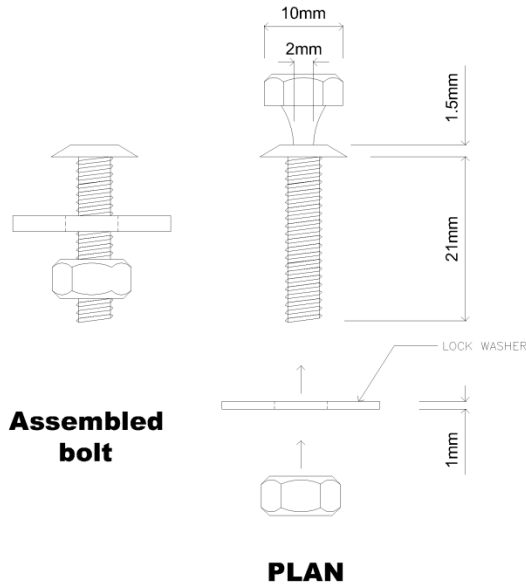

Lock washer

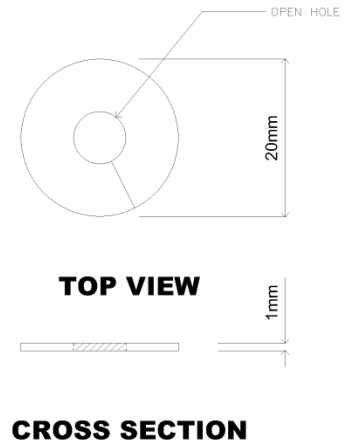

Bolt attachment

STANDARD BOLT 2

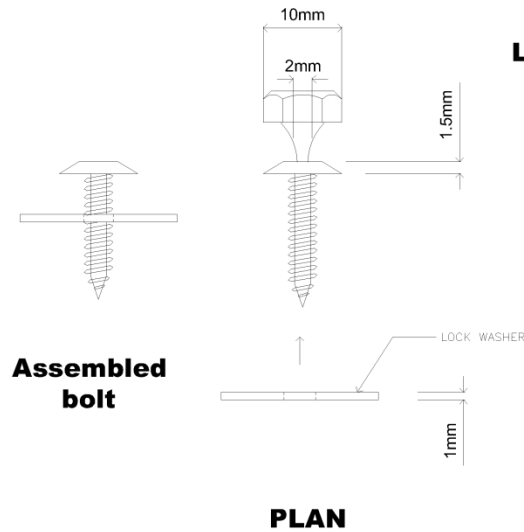

Lock washer

